

FAST RECOVERY RECTIFIER DIODES

- VERY FAST FORWARD AND REVERSE RECOVERY DIODES

SUITABLE APPLICATION

- SWITCHING POWER TRANSISTORS DRIVER CIRCUITS (SERIES DIODES IN ANTISATURATION CLAMP SPEED UP DIODE IN DISCRETE DARLINGTON...)
- THYRISTORS GATE DRIVER CIRCUITS
- HIGH FREQUENCY RECTIFICATION

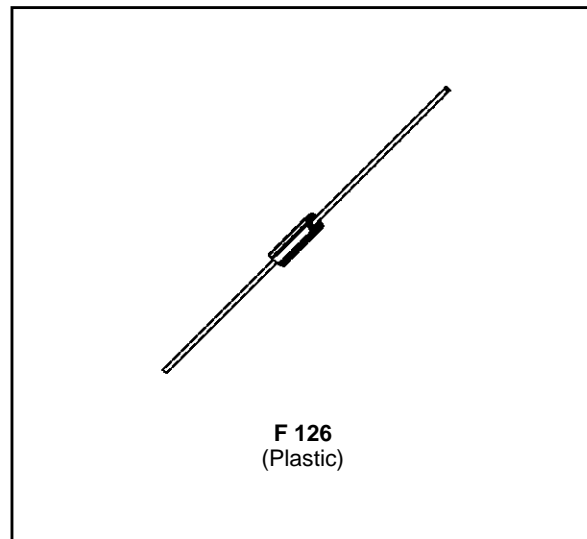

ABSOLUTE RATINGS (limiting values)

Symbol	Parameter		Value	Unit
I_{FRM}	Repetive Peak Forward Current	$t_p \leq 20\mu s$	20	A
$I_F (AV)$	Average Forward Current*	$T_a = 25^\circ C$ $\delta = 0.5$	1	A
I_{FSM}	Surge non Repetitive Forward Current	$t_p = 10ms$ Sinusoidal	20	A
P_{tot}	Power Dissipation*	$T_a = 25^\circ C$	1.7	W
T_{stg} T_j	Storage and Junction Temperature Range		- 40 to 125	$^\circ C$
T_L	Maximum Lead Temperature for Soldering during 10s at 4mm from Case		230	$^\circ C$

Symbol	Parameter	PLQ 08	PLQ 1	Unit
V_{RRM}	Repetitive Peak Reverse Voltage	80	100	V
V_{RSM}	Non Repetitive Peak Reverse Voltage	80	100	V

THERMAL RESISTANCE

Symbol	Parameter	Value	Unit
$R_{th (j-a)}$	Junction-ambient*	60	$^\circ C/W$

* On infinite heatsink with 10mm lead length.

ELECTRICAL CHARACTERISTICS

STATIC CHARACTERISTICS

Symbol	Test Conditions		Min.	Typ.	Max.	Unit
I_R	$T_j = 25^\circ\text{C}$	$V_R = V_{RRM}$			10	μA
	$T_j = 100^\circ\text{C}$				0.5	mA
V_F	$T_j = 25^\circ\text{C}$	$I_F = 1\text{A}$			1.1	V

RECOVERY CHARACTERISTICS

Symbol	Test Conditions			Min.	Typ.	Max.	Unit
t_{rr}	$T_j = 25^\circ\text{C}$ $V_R = 30\text{V}$	$I_F = 1\text{A}$ See figure 12	$di_F/dt = -50\text{A}/\mu\text{s}$			50	ns
t_{fr}	$T_j = 25^\circ\text{C}$ Measured at $1.1 \times V_F$	$I_F = 1\text{A}$	$t_r = 20\text{ns}$			50	ns

Figure 1. Power losses versus average current.

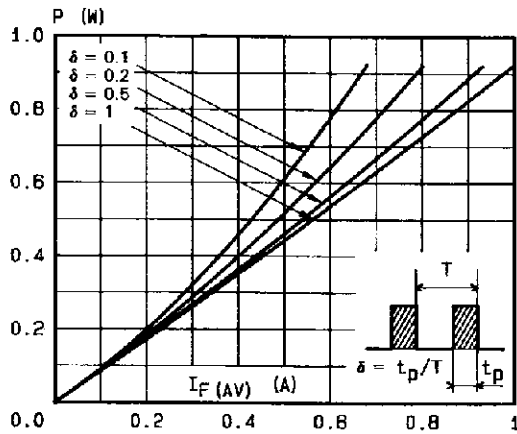

Figure 2. Allowable DC current versus ambient temperature.

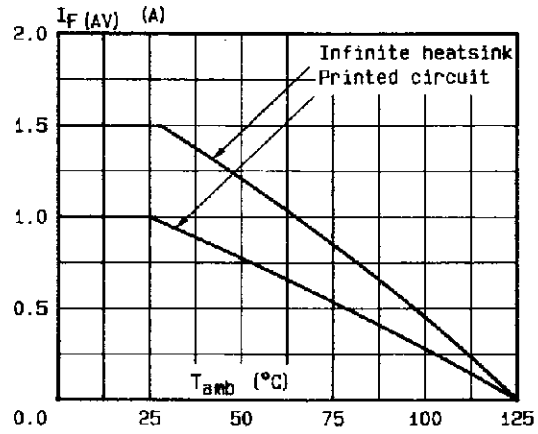

Figure 3. Non repetitive surge peak current versus number of cycles.

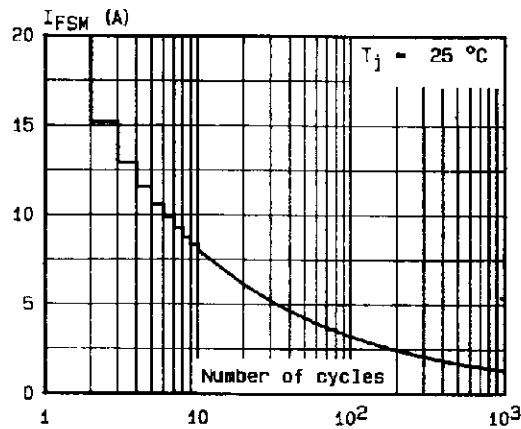

Figure 4. Transient thermal impedance junction-ambient. Printed circuit versus pulse duration (L = 10 mm).

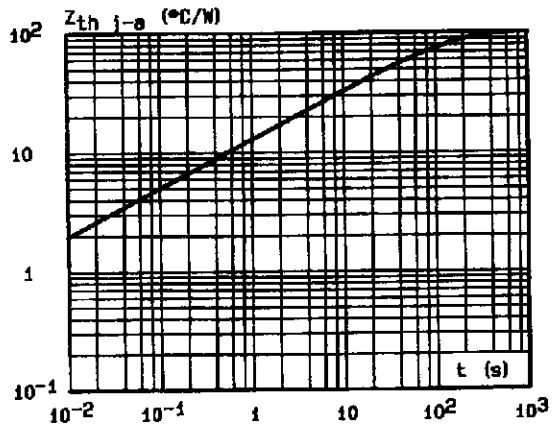

Figure 5. Voltage drop versus forward current.

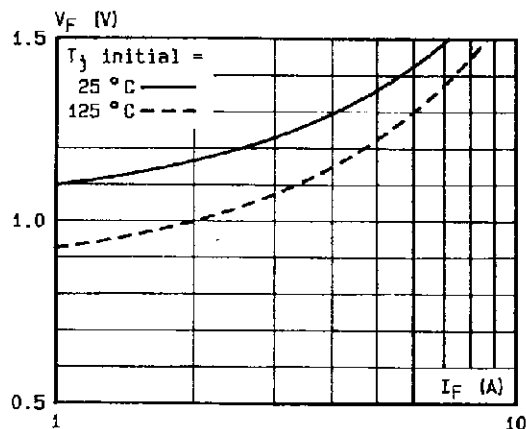

Figure 6. Voltage drop versus forward current.

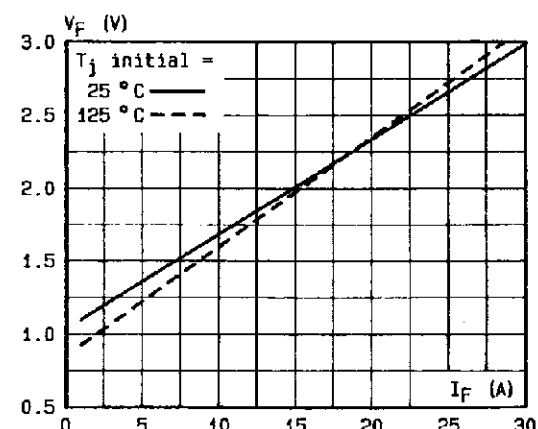

Figure 7. Capacitance versus reverse voltage applied.

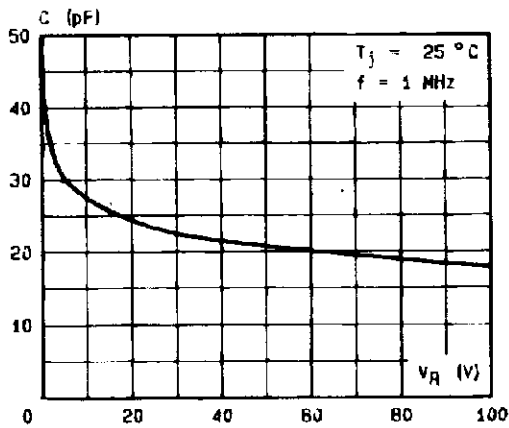

Figure 8. Thermal resistance junction-ambient versus lead length.

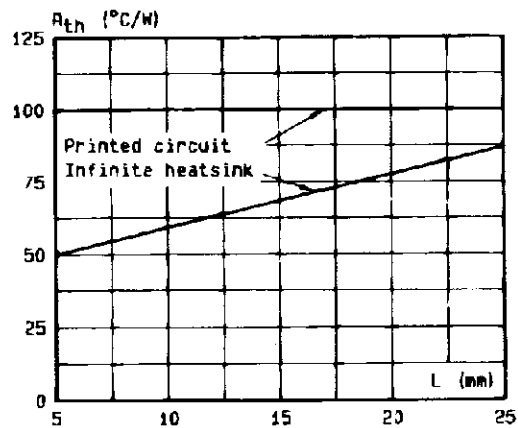

Figure 9. Recovery time versus di_F/dt .

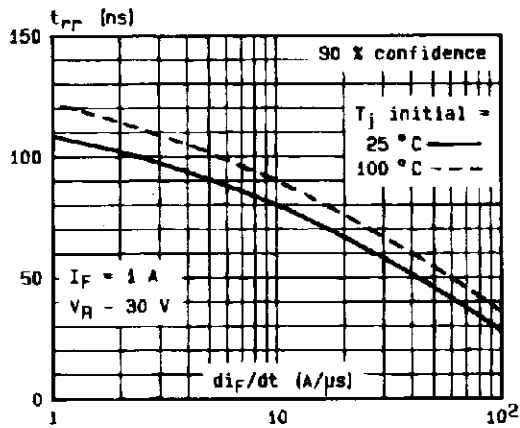

Figure 10. Peak reverse current versus di_F/dt .

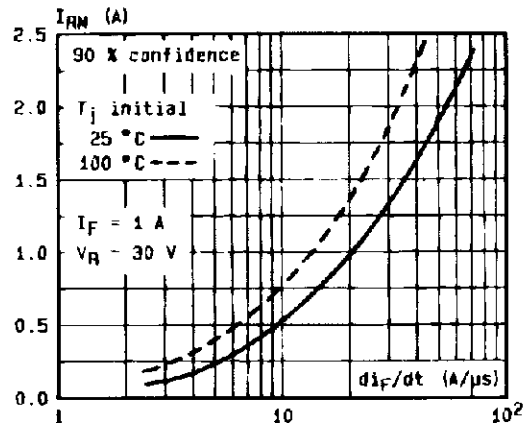

Figure 11. Dynamic parameters versus junction temperature.

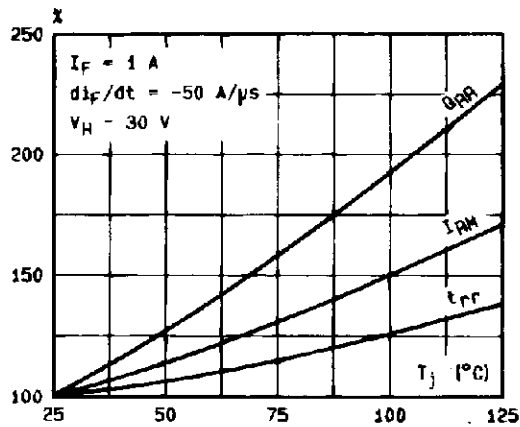
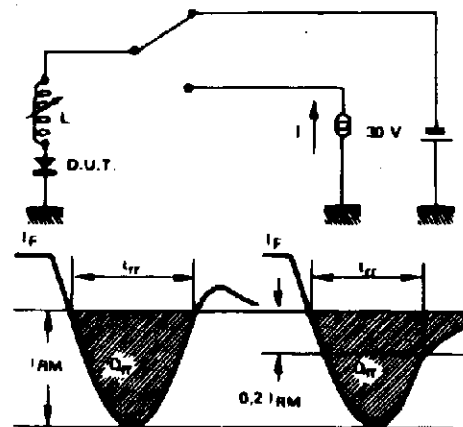
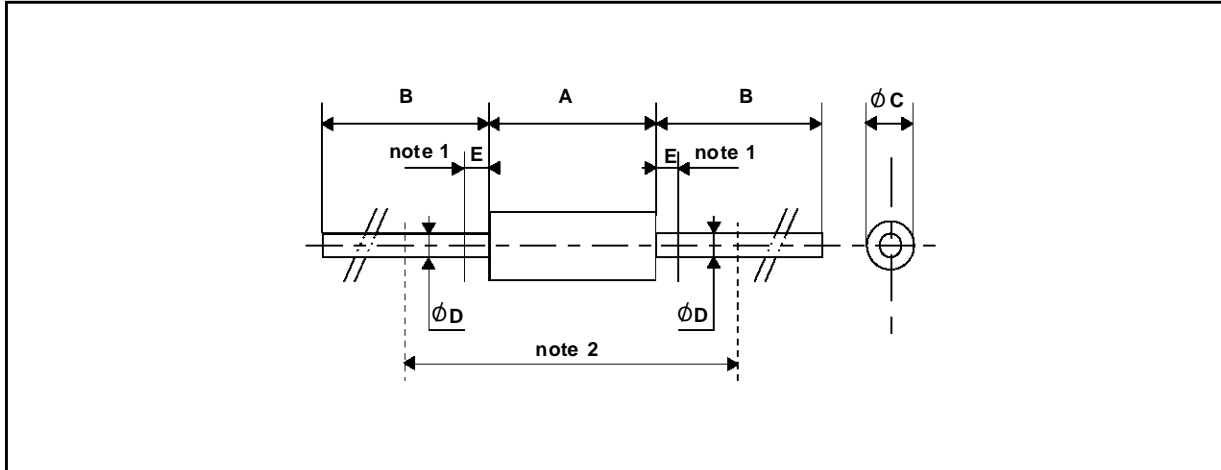

Figure 12. Measurement of t_{rr} (fig. 8) and I_{RM} (fig. 10).



PACKAGE MECHANICAL DATA

F 126 (Plastic)



REF.	DIMENSIONS				NOTES
	Millimeters		Inches		
	Min.	Max.	Min.	Max.	
A	6.05	6.35	0.238	0.250	1 - The lead diameter $\varnothing D$ is not controlled over zone E 2 - The minimum axial length within which the device may be placed with its leads bent at right angles is 0.59" (15 mm)
B	26		1.024		
$\varnothing C$	2.95	3.05	0.116	0.120	
$\varnothing D$	0.76	0.86	0.029	0.034	
E		1.27		0.050	

Cooling method: by convection (method A)
 Marking: type number
 Weight: 0.4g

Information furnished is believed to be accurate and reliable. However, SGS-THOMSON Microelectronics assumes no responsibility for the consequences of use of such information nor for any infringement of patents or other rights of third parties which may result from its use. No license is granted by implication or otherwise under any patent or patent rights of SGS-THOMSON Microelectronics. Specifications mentioned in this publication are subject to change without notice. This publication supersedes and replaces all information previously supplied. SGS-THOMSON Microelectronics products are not authorized for use as critical components in life support devices or systems without express written approval of SGS-THOMSON Microelectronics.

© 1994 SGS-THOMSON Microelectronics - Printed in Italy - All rights reserved.

SGS-THOMSON Microelectronics GROUP OF COMPANIES

Australia - Brazil - France - Germany - Hong Kong - Italy - Japan - Korea - Malaysia - Malta - Morocco - The Netherlands - Singapore - Spain - Sweden - Switzerland - Taiwan - United Kingdom - U.S.A.